

# DL8271: LED测温体温手环IC芯片

测温, 一键切换

Temperature  
switch



DL8271触摸温度检测LED显示IC芯片

DL8271 SOP16

触摸温度检测带小数点后1位显示芯片

规格书

静态电流1 - 2UA

# DL8271触摸温度检测LED显示IC芯片

十位数

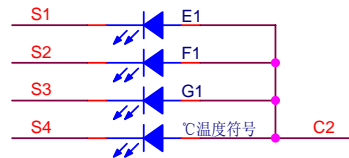
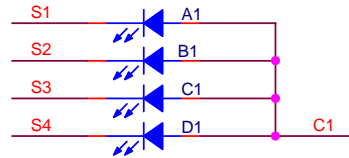

个位数

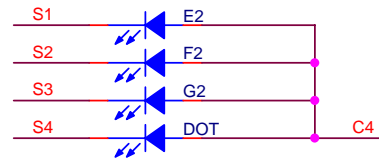
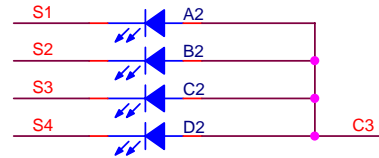

小数位

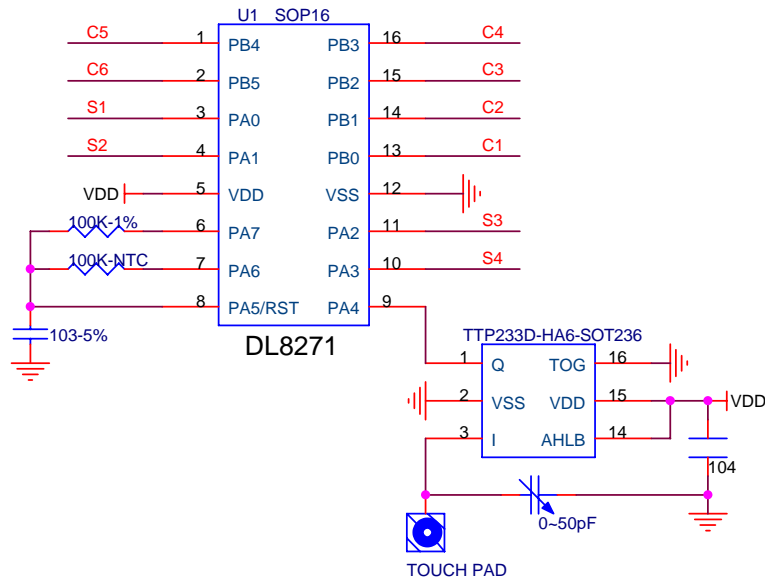
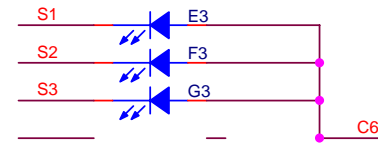
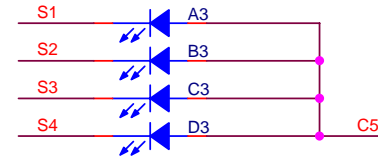

## 功能说明：

工作电压：3V

热敏电阻参数：100K 3950 1%

上电全亮后熄灭；

触摸显示2.5秒温度后灭；

检测温度范围：1-99度（带小数点后1位）

DL8271触摸温度检测LED显示IC芯片

- 封装说明

(16-SOP)

