

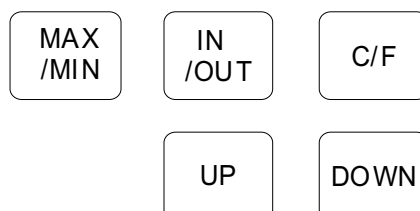

一) 功能特性

- 1) 工作電壓1.5V, 超低電源功耗
- 2) 基本的時間顯示, 可調節12/24小時制式
- 3) 鬧鐘功能
- 2) 可顯示室內溫度, 室外溫度 和室內濕度
- 3) 最大最小溫度和濕度記錄功能
- 4) 五段濕度舒適度顯示
- 5) 室內溫度測量範圍: -10~+50 degC(14~122degF)
室外溫度測量範圍: -20~+70 degC(-4~158degF)
溫度顯示精度: 0.1degC
溫度準確度: +/- 1 degC
- 6) 濕度測量範圍: 20~90 %RH
濕度顯示精度: 1 %RH
濕度準確度: +/-5 %RH

二) 液晶顯示圖案

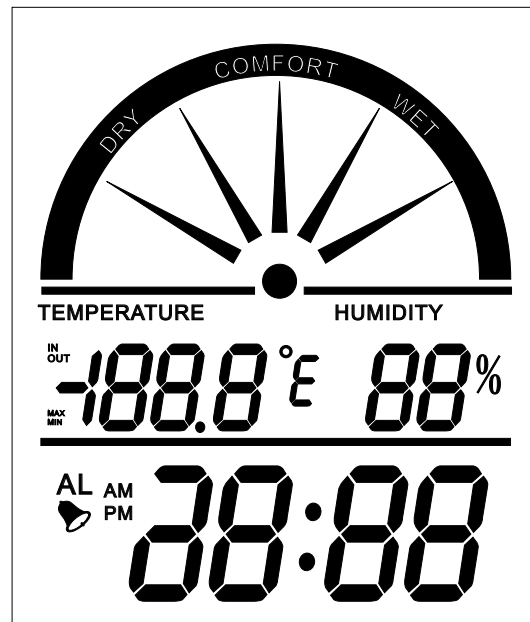



三) 設定時鐘

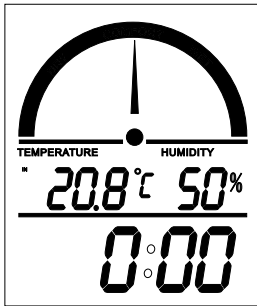

時鐘模式

按<C/F>鍵兩秒

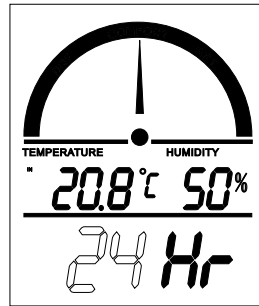

按<UP>、<DOWN>設定12/24制式

按<C/F>鍵確認

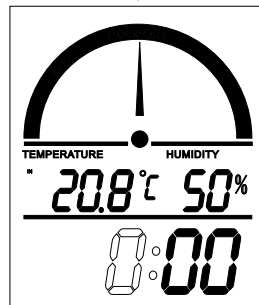

按<UP>、<DOWN>設定小時

按<C/F>鍵確認

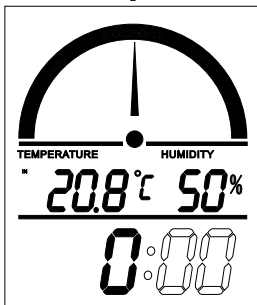

按<C/F>鍵確認

按<UP>、<DOWN>設定分鐘

四) 設定鬧鐘

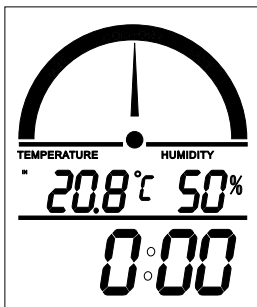

時鐘模式

按<DOWN>鍵轉換

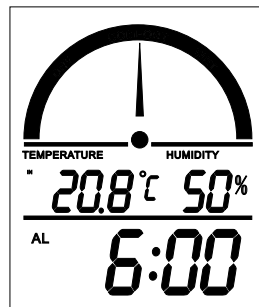

鬧鐘模式

按<C/F>鍵兩秒

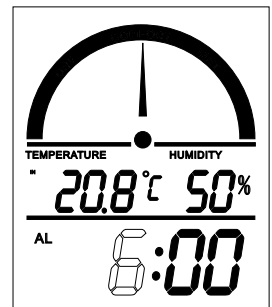

按<UP>、<DOWN>設定小時

按<C/F>鍵確認

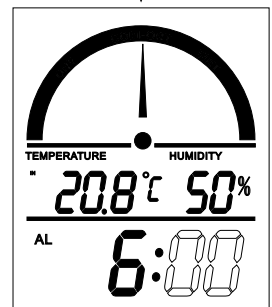

按<UP>、<DOWN>設定分鐘

按<C/F>鍵確認

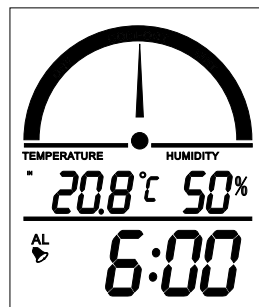

五) 五段濕度舒適度顯示

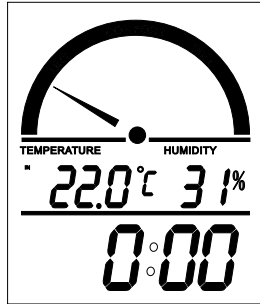

DRY: 濕度低於34%

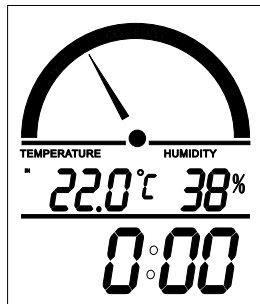

COMFORT/DRY: 濕度於35-40%

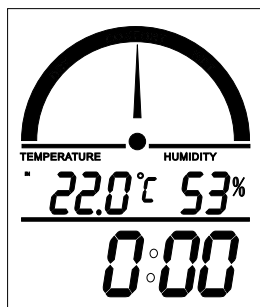

COMFORT/IDEAL: 濕度於41-55%

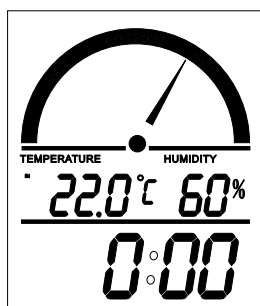

COMFORT/WET: 濕度於56-64%

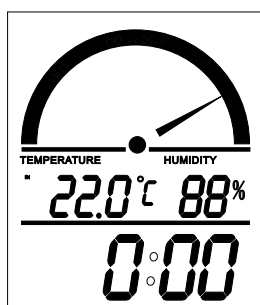

WET: 濕度高於65%



六) IC出脚图

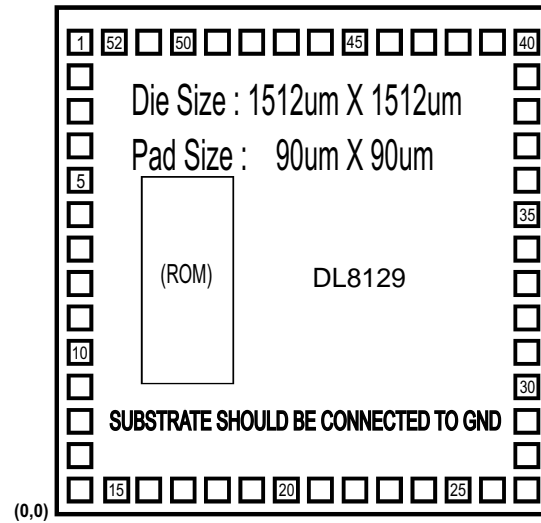

NO	NAME	X	Y	NO	NAME	X	Y
1	BAK	69.75	1422.25	27	SEG13	1442.25	69.75
2	XIN	69.75	1325.25	28	SEG14	1442.25	186.75
3	XOUT	69.75	1221.75	29	SEG15	1442.25	290.25
4	GND	69.75	1118.25	30	SEG16	1442.25	393.75
5	VDD1	69.75	1014.75	31	SEG17	1442.25	497.25
6	VDD2	69.75	911.25	32	SEG18	1442.25	600.75
7	VDD3	69.75	807.75	33	SEG19	1442.25	704.25
8	CUP1	69.75	704.25	34	SEG20	1442.25	807.75
9	CUP2	69.75	600.79	35	SEG21	1442.30	911.29
10	COM1	69.75	497.25	36	SEG22	1442.25	1014.75
11	COM2	69.75	393.75	37	SEG23	1442.25	1118.25
12	COM3	69.75	290.25	38	IOA1	1442.25	1221.75
13	COM4	69.75	186.75	39	IOA2	1442.25	1325.25
14	COM5	69.75	69.75	40	IOA3	1442.25	1442.25
15	SEG1	186.75	69.75	41	IOA4	1325.25	1442.25
16	SEG2	290.25	69.75	42	IOB1	1221.75	1442.20
17	SEG3	393.75	69.75	43	IOB2	1118.25	1442.25
18	SEG4	497.25	69.75	44	IOB3	1014.75	1442.25
19	SEG5	600.75	69.75	45	BZ	912.42	1441.89
20	SEG6	704.25	69.75	46	IOC1	807.75	1442.25
21	SEG7	807.75	69.75	47	IOC2	704.25	1442.25
22	SEG8	911.25	69.75	48	IOC3	600.75	1442.25
23	SEG9	1014.75	69.75	49	IOC4	497.25	1442.25
24	SEG10	1118.25	69.75	50	RESET	393.75	1442.25
25	SEG11	1221.75	69.75	51	INT	290.25	1442.25
26	SEG12	1325.25	69.75	52	N.C.	186.75	1442.25

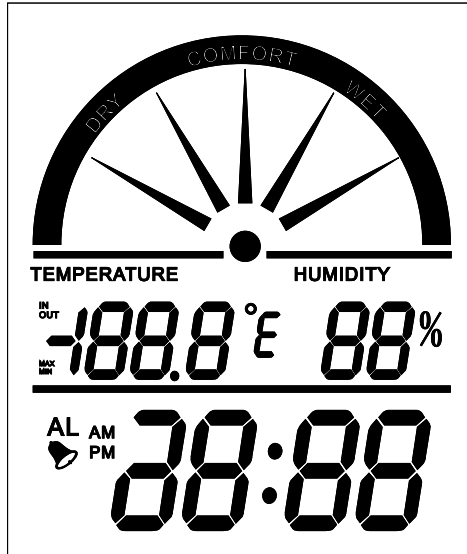

1/5 Duty, 1/3BIAS, Vlcd 4.5V

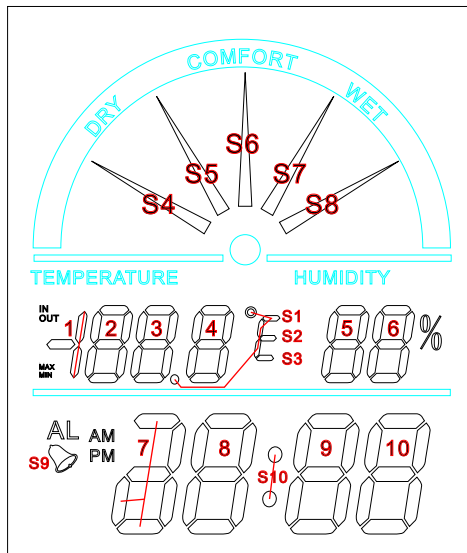

Remark:

藍色部分可作絲印或與S1點共作一點

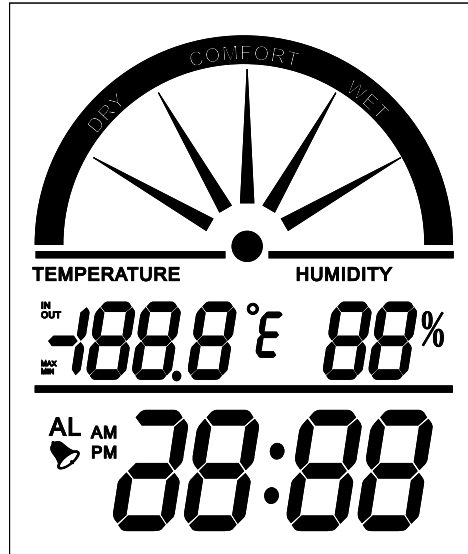

1/5 Duty, 1/3BIAS, Vlcd 4.5V

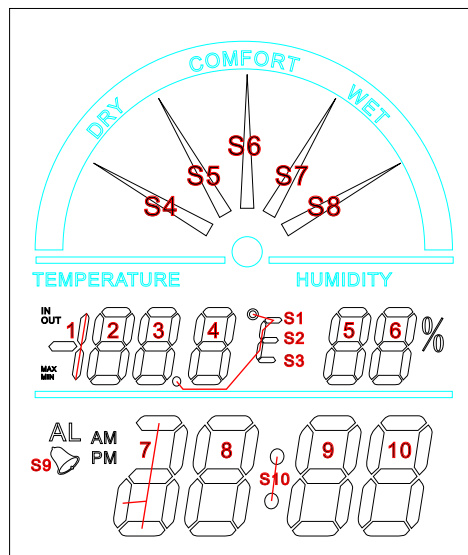

	SEG1	SEG2	SEG3	SEG4	SEG5	SEG6	SEG7	SEG8	SEG9	SEG10	SEG11
COM1		5D	6E	6D	S4		7C	8E	8D	8C	9E
COM2	5E	5C	6G	6C	S5		7B	8F	8G	8B	9F
COM3	5G	5B	6F	6B	S6		7ADEG		8A	S10	
COM4	5F	5A	%	6A	S7						
COM5		S3		S2	S8		S1				
	SEG12	SEG13	SEG14	SEG15	SEG16	SEG17	SEG18	SEG19	SEG20	SEG21	SEG22
COM1	9D	9C	10E	10D	10C	4A	4F	3A	3F	2A	2F
COM2	9G	9B	10F	10G	10B	4B	4G	3B	3G	2B	2G
COM3	9A	OUT		10A		4C	4E	3C	3E	2C	2E
COM4						4D	PM	3D	MAX	2D	1BC
COM5						IN	AM	AL	MIN	S9	1G

Remark:

藍色部分可作絲印或與S1點共作一點

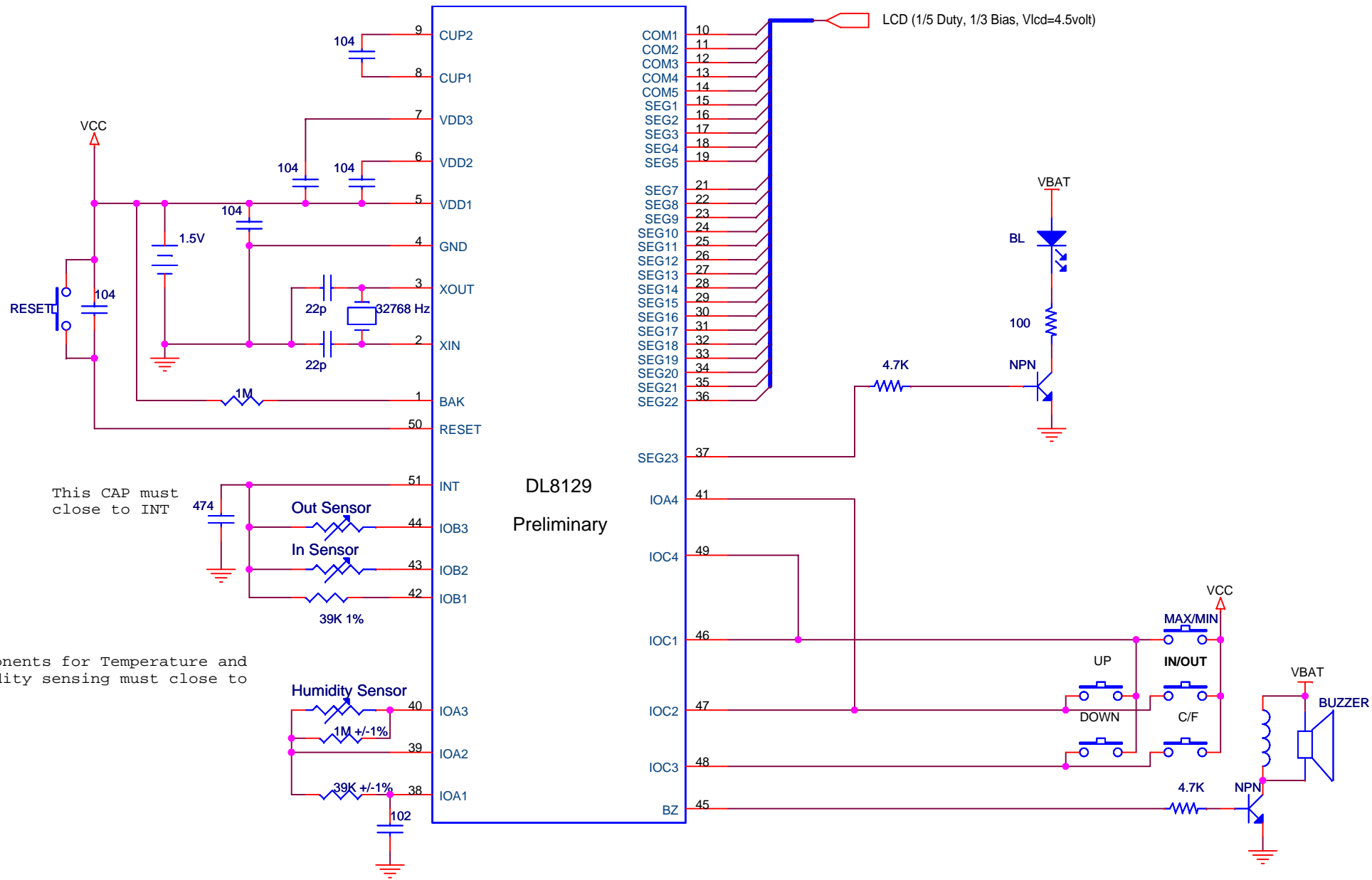

Title		
Size	Document Number	Rev
	DL8129 Preliminary	1.0
Date:	Tuesday, April 02, 2013	Sheet 1 of 3