

CUSTOMER CODE	JUN ZE	CUSTOMER NO.	
---------------	--------	--------------	--

请确认此型号所有图纸，签字确认：

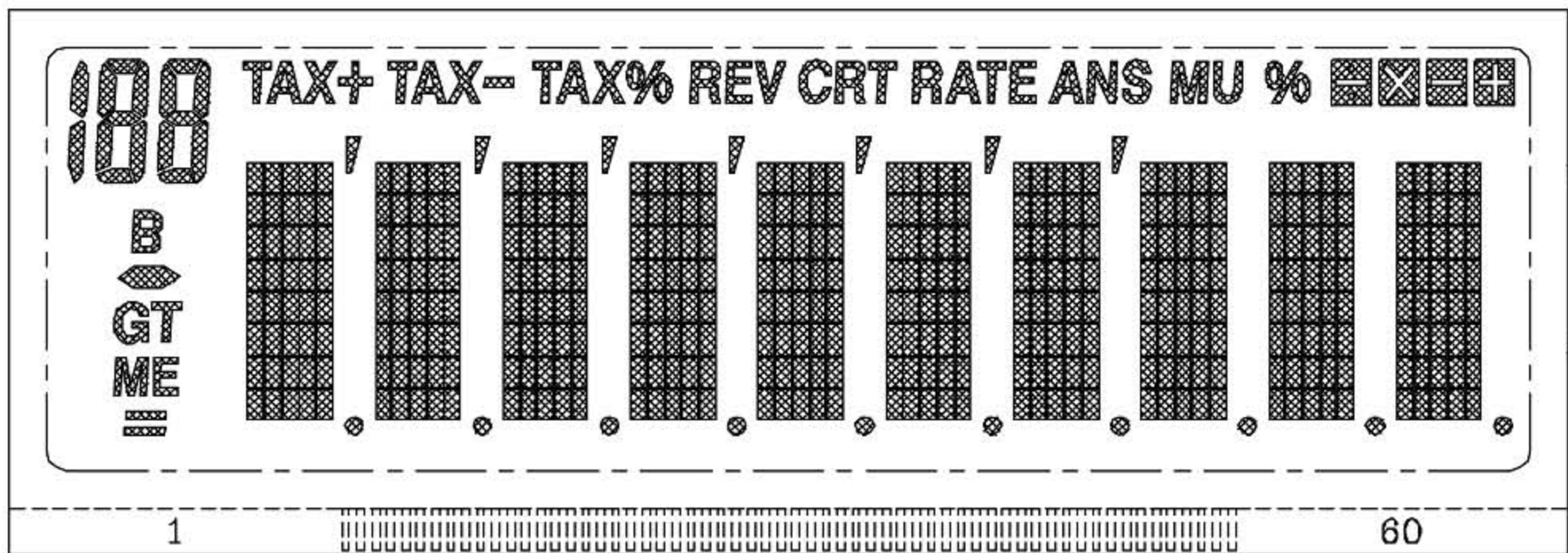

显示效果图

1. DISPLAY TYPE	<input checked="" type="checkbox"/> TN <input type="checkbox"/> HTN <input type="checkbox"/> STN	4. DRIVE METHOD	1/8DUTY 1/3BIAS	NAME	DATE	DRAWING NO.	DL5519		
DISPLAY SIZE	83.0X29.0/28.5	5. OPERATING VOLTAGE	3.0V	DRAWING1 BY	PENG			2009.05.25	
2. VIEWING DIRECTION	80' CLOCK	6. OPERATING TEMP	0°C~50°C	CHECKED BY					
3. FRONT POLARIZER	POSITIVE	7. STORAGE TEMP	-10°C~60°C	APPROVED BY	SUO				
4. REAR POLARIZER	REFLECTIVE	8. CONNECTOR	<input checked="" type="checkbox"/> ZEBRA <input type="checkbox"/> HEAT SEAL <input type="checkbox"/> PIN TYPE			DATA RESERVE	TOLERANCE: ±0.2	UNIT: mm	SHEET: 3/3
						D:\DWG\HP	ANGLES: ±0.5°	SCALE: NTS	SIZE: A4

CUSTOMER CODE JUN ZE CUSTOMER NO.

请确认此型号所有图纸, 签字确认:

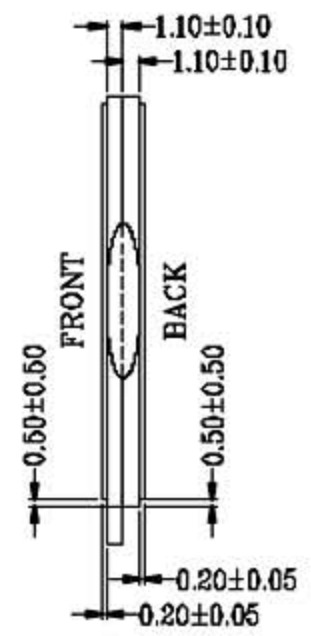
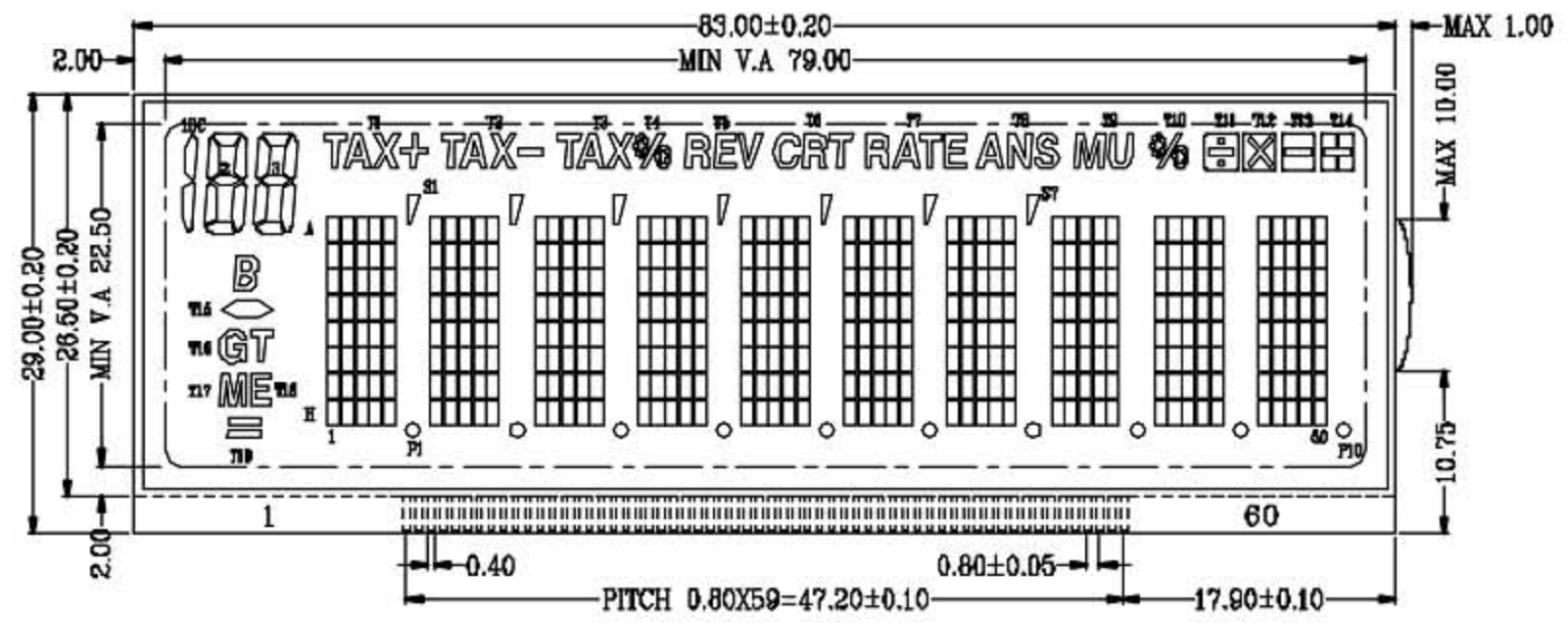

PTN	1	2	3	4	5	6	7	8	9	10	11	12	13	14	15	16	17	18	19	20	21	22	23	24	25	26	27	28	29	30	31	32	33	34	35	36	37	38	39	40	41	42	43	44	45	46	47	48	49	50	51	52	53	54	55	56	57	58	59	60
COMB	COMB									T17	T18	T16	T15	B	P1	S1	3E	3D	3C	P2	S2	3G	3H	3A	P3	S3	3F	T1	T2	P4	S4	T3	T4	T5	S5	T6	T7	T8	P6	S6	T9	T10	T11	P7	S7	T12	T13	T14	P8	S8	2C	2C	2B	2A	P9	2F	2E	2D	1BC	P10
COM7		COM7								A1	A2	A3	A4	A5	A6	A7	A8	A9	A10	A11	A12	A13	A14	A16	A16	A17	A18	A19	A20	A21	A22	A23	A24	A25	A26	A27	A28	A29	A30	A31	A32	A33	A34	A35	A36	A37	A38	A39	A40	A41	A42	A43	A44	A45	A46	A47	A48	A49	A50	
COM5			COM5							B1	B2	B3	B4	B5	B6	B7	B8	B9	B10	B11	B12	B13	B14	B15	B16	B17	B18	B19	B20	B21	B22	B23	B24	B25	B26	B27	B28	B29	B30	B31	B32	B33	B34	B35	B36	B37	B38	B39	B40	B41	B42	B43	B44	B45	B46	B47	B48	B49	B50	
COM5				COM5						C1	C2	C3	C4	C5	C6	C7	C8	C9	C10	C11	C12	C13	C14	C15	C16	C17	C18	C19	C20	C21	C22	C23	C24	C25	C26	C27	C28	C29	C30	C31	C32	C33	C34	C35	C36	C37	C38	C39	C40	C41	C42	C43	C44	C45	C46	C47	C48	C49	C50	
COM4					COM4					D1	D2	D3	D4	D5	D6	D7	D8	D9	D10	D11	D12	D13	D14	D15	D16	D17	D18	D19	D20	D21	D22	D23	D24	D25	D26	D27	D28	D29	D30	D31	D32	D33	D34	D35	D36	D37	D38	D39	D40	D41	D42	D43	D44	D45	D46	D47	D48	D49	D50	
COM3						COM3				E1	E2	E3	E4	E5	E6	E7	E8	E9	E10	E11	E12	E13	E14	E15	E16	E17	E18	E19	E20	E21	E22	E23	E24	E25	E26	E27	E28	E29	E30	E31	E32	E33	E34	E35	E36	E37	E38	E39	E40	E41	E42	E43	E44	E45	E46	E47	E48	E49	E50	
COM2							COM2			F1	F2	F3	F4	F5	F6	F7	F8	F9	F10	F11	F12	F13	F14	F15	F16	F17	F18	F19	F20	F21	F22	F23	F24	F25	F26	F27	F28	F29	F30	F31	F32	F33	F34	F35	F36	F37	F38	F39	F40	F41	F42	F43	F44	F45	F46	F47	F48	F49	F50	
COM1								COM1		G1	G2	G3	G4	G5	G6	G7	G8	G9	G10	G11	G12	G13	G14	G15	G16	G17	G18	G19	G20	G21	G22	G23	G24	G25	G26	G27	G28	G29	G30	G31	G32	G33	G34	G35	G36	G37	G38	G39	G40	G41	G42	G43	G44	G45	G46	G47	G48	G49	G50	
COM0									COM0	T19	H1	H2	H3	H4	H5	H6	H7	H8	H9	H10	H11	H12	H13	H14	H15	H16	H17	H18	H19	H20	H21	H22	H23	H24	H25	H26	H27	H28	H29	H30	H31	H32	H33	H34	H35	H36	H37	H38	H39	H40	H41	H42	H43	H44	H45	H46	H47	H48	H49	H50

1. DISPLAY TYPE	<input checked="" type="checkbox"/> TN <input type="checkbox"/> HTN <input type="checkbox"/> STN	4. DRIVE METHOD	1/9DUTY 1/3BIAS	NAME	DATE	DRAWING NO.	DL5519		
DISPLAY SIZE	83.0X29.0/28.5	5. OPERATING VOLTAGE	3.0V	DRAWING1 BY	PENG			2009.05.25	
2. VIEWING DIRECTION	60° CLOCK	6. OPERATING TEMP	0°C~50°C	CHECKED BY		DATA RESERVE	TOLERANCE:±0.2	UNIT: mm	SHEET:1/3
3. FRONT POLARIZER	POSITIVE	7. STORAGE TEMP	-10°C~60°C	APPROVED BY	SUO				
4. REAR POLARIZER	REFLECTIVE	8. CONNECTOR	<input checked="" type="checkbox"/> ZEBRA <input type="checkbox"/> HEAT SEAL <input type="checkbox"/> PIN TYPE						

CUSTOMER CODE	JUN ZE	CUSTOMER NO.	
---------------	--------	--------------	--

请确认此型号所有图纸，签字确认：

仅供走线参考

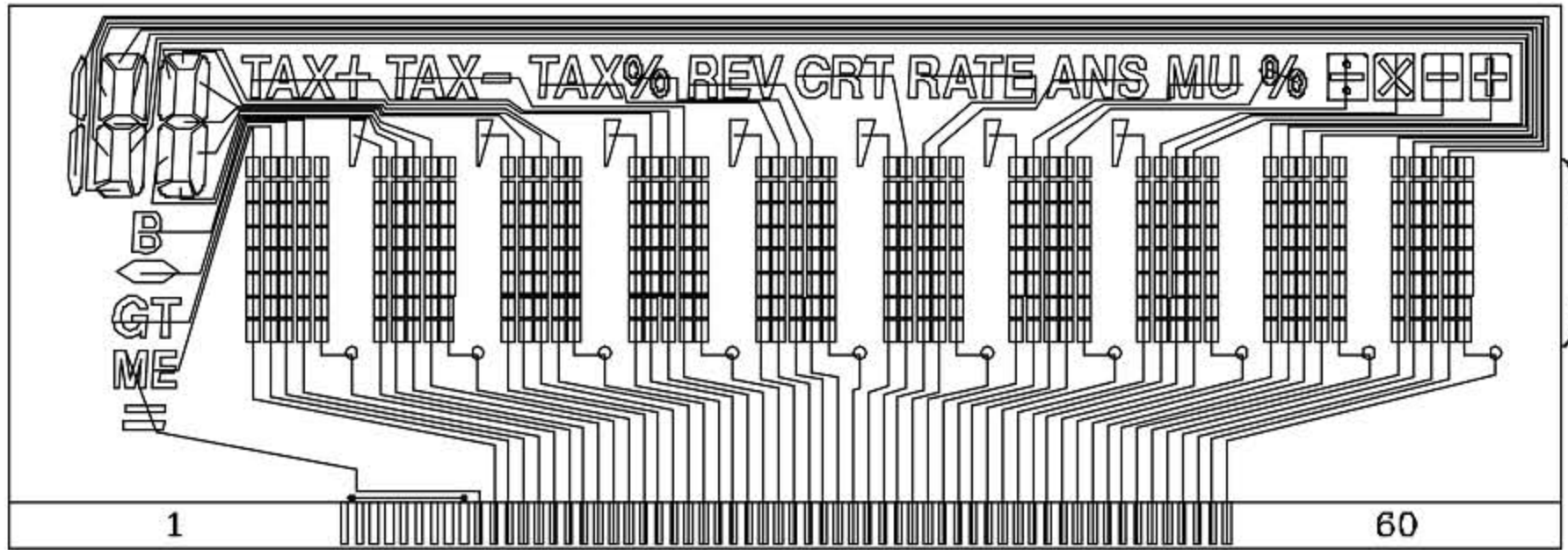

SEG

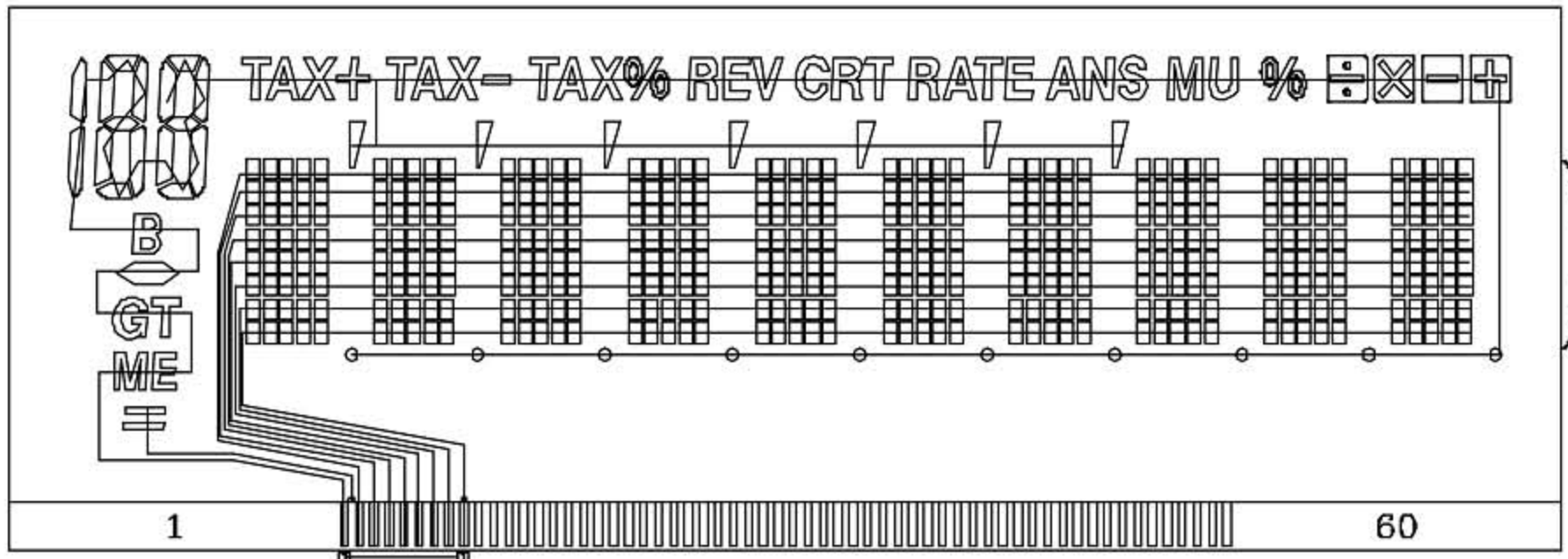

COM

1. DISPLAY TYPE	■ TN □ HTN □ STN	4. DRIVE METHOD	1/9DUTY 1/3BIAS	NAME	DATE	DRAWING NO.	DL5519		
DISPLAY SIZE	83.0X29.0/28.5	5. OPERATING VOLTAGE	3.0V	DRAWING1 BY	PENG			2009.05.25	
2. VIEWING DIRECTION	60° CLOCK	6. OPERATING TEMP	0°C~50°C	CHECKED BY					
3. FRONT POLARIZER	POSITIVE	7. STORAGE TEMP	-10°C~60°C	APPROVED BY	SUO				
4. REAR POLARIZER	REFLECTIVE	8. CONNECTOR	■ ZEBRA □ HEAT SEAL □ PIN TYPE			DATA RESERVE	TOLERANCE: ±0.2	UNIT: mm	SHEET: 2/3
						D:\DWG\HP	ANGLES: ±0.5°	SCALE: NTS	SIZE: A4

CUSTOMER CODE	JUN ZE	CUSTOMER NO.	
---------------	--------	--------------	--

请确认此型号所有图纸，签字确认：

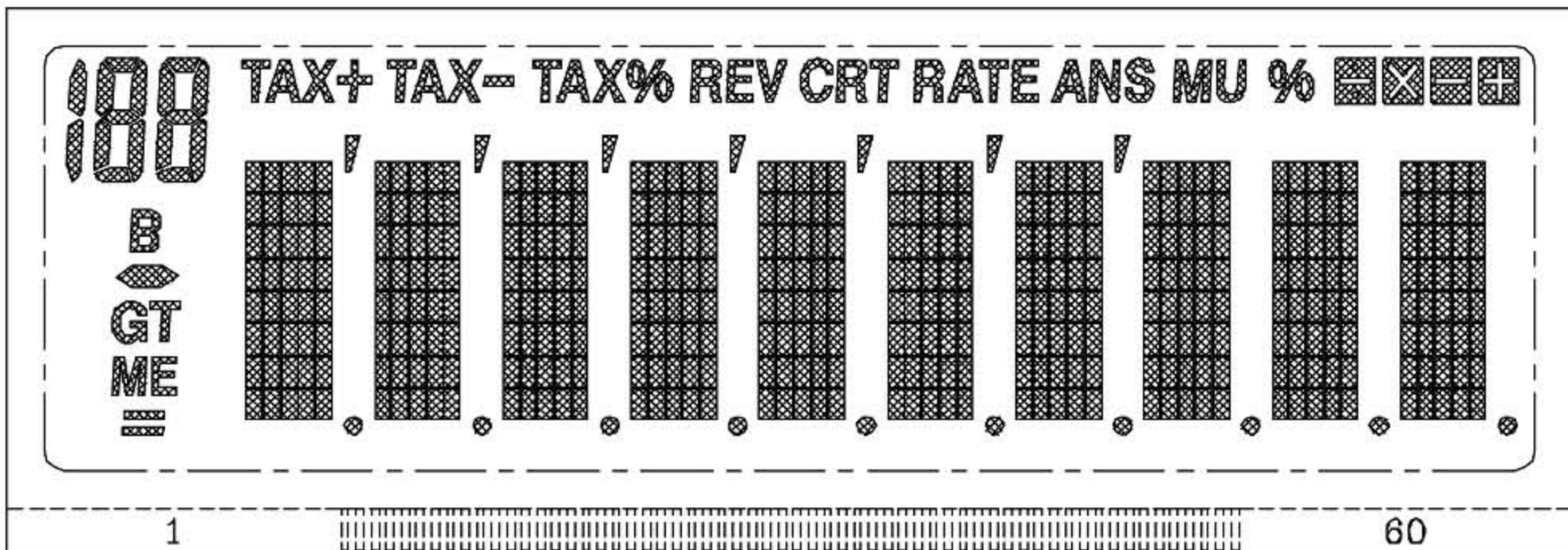

显示效果图

1. DISPLAY TYPE	<input checked="" type="checkbox"/> TN <input type="checkbox"/> HTN <input type="checkbox"/> STN	4. DRIVE METHOD	1/8DUTY 1/3BIAS	NAME	DATE	DRAWING NO.	DL5519		
DISPLAY SIZE	83.0X29.0/28.5	5.OPERATING VOLTAGE	3.0V	DRAWING1 BY	PENG				
2. VIEWING DIRECTION	80' CLOCK	6.OPERATING TEMP	0°C~50°C	DRAWING2 BY					
3. FRONT POLARIZER	POSITIVE	7.STORAGE TEMP	-10°C~60°C	CHECKED BY					
4. REAR POLARIZER	REFLECTIVE	8.CONNECTOR	<input checked="" type="checkbox"/> ZEBRA <input type="checkbox"/> HEAT SEAL <input type="checkbox"/> PIN TYPE	APPROVED BY	SUO				
						DATA RESERVE	TOLERANCE:±0.2	UNIT: mm	SHEET:3/3
						D:\DWG\HP	ANGLES:±0.5°	SCALE: NTS	SIZE:A4

TOP VIEW

LCD9*51

- 1.工作电压1.5V
- 2.R1 1M +/-5%
- 3.电容精度+/-20%
- 4.LCD工作电压3V 1/9duty,1/3baiss
5. LCD Pin为示意描述, PCB根据实际LCD图纸确定
6. SW1/SW2 为拨码开关,默认为悬空
7. SW3 为Bonding Option, 默认为悬空

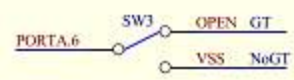
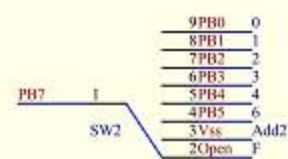
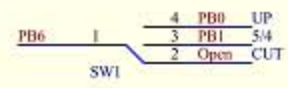
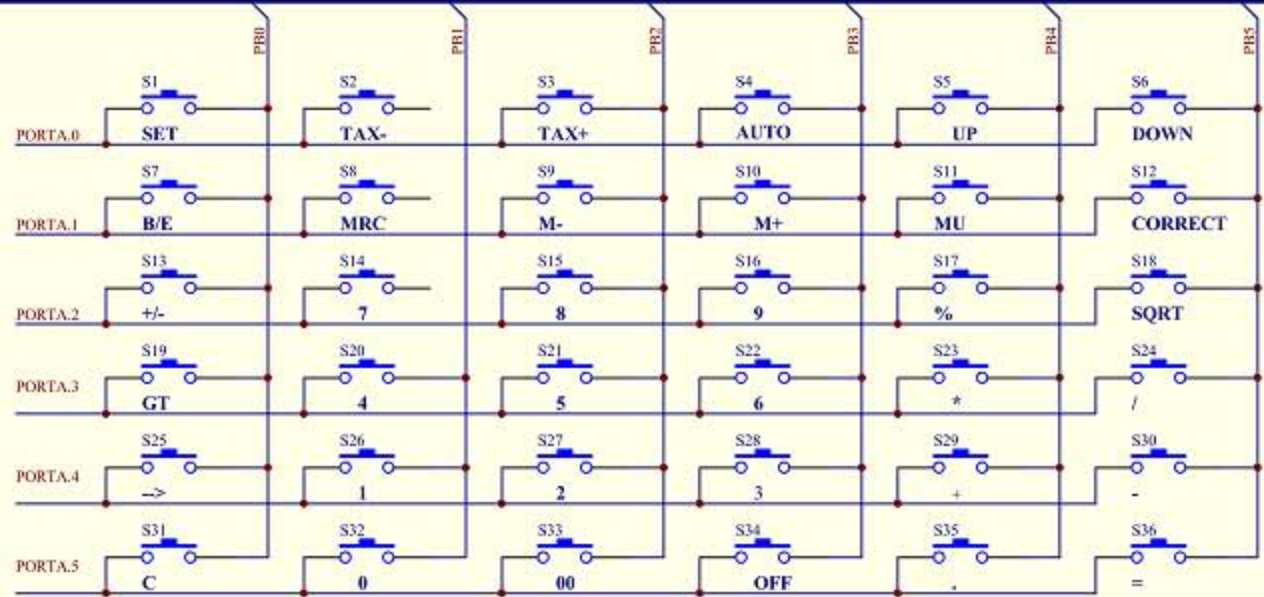
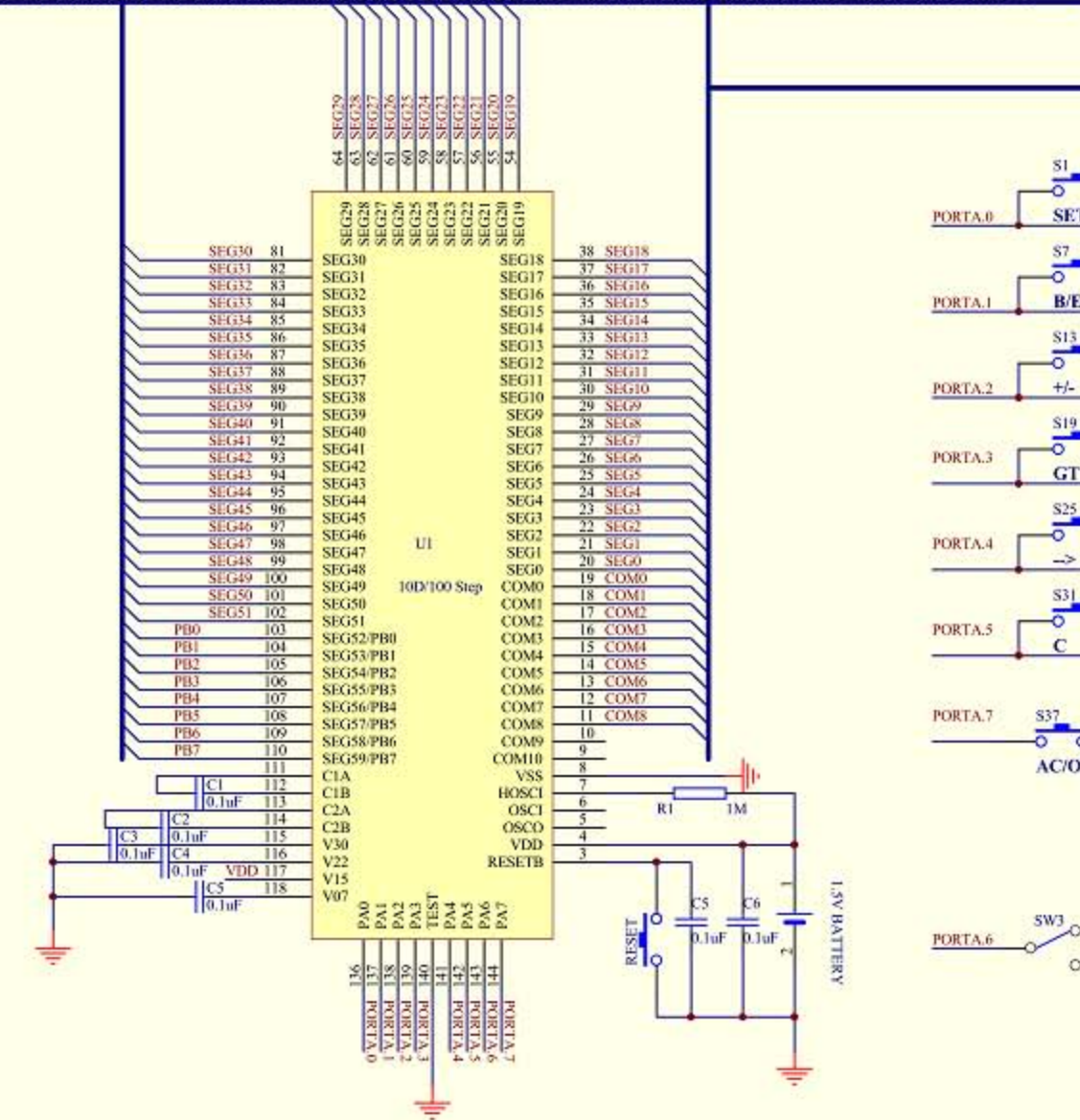
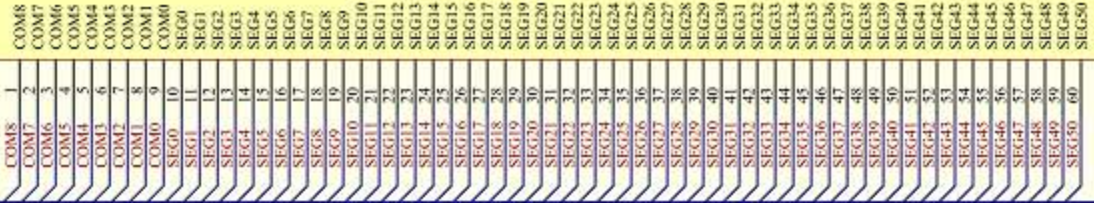

Title			10D 120/100 step Calc		
Size	Number			Revision	VL1
B					
Date:	15-Jul-2009	Sheet	of		
File:	D:\Elan\Jr-X10\Hardware\JR-X10.Ddb	Drawn By:	Sefc		

01
0.220869420

TAX+

TAX-

AUTO
REVIEW

CORRECT

▲

▼

RATE

%

√

▶

DEL

B/E

$\frac{+}{-}$

9⁷

8⁸

7⁹

×

÷

C

8⁴

5⁵

6⁶

-

MRC

AC

1¹

2²

3³

+

M-

0⁰

00

.

=

+

M+